



ORGA-LINE for TANDEMBOX

Selection and ordering guide

Time for essential values

Set new standards for working in your kitchen. ORGA-LINE, the adjustable inner dividing system for drawers and pull-outs with double walled BOXSIDE, provides the perfect solution. Organise your storage space to meet individual needs using the adjustable ORGA-LINE system. Profit from interior organisation that is customised to the items being stored while, emphasising beauty, quality and durability at the same time.

The advantages of ORGA-LINE at a glance:

- Optimal storage space utilisation, customised to the item(s) being stored
- Complete sets make selection and ordering easier
- Special carcass widths provide flexible design options
- Stainless steel boxes and nylon parts that are durable and easy-to-clean
- Sets can be customised
- Can also be used with inner drawers and/or inner pull-outs
- Award-winning design



DYNAMIC SPACE – More fun in the kitchen

What should the kitchen standard be? Our DYNAMIC SPACE initiative looks into this question. Our goal: More storage space and improved quality of motion for a new kitchen standard. If the “planning in 5 zones rule” is applied then you get to keep the fun and lose the hassle.

This is what DYNAMIC SPACE can do for you:

- Ample, well-organised storage space using adjustable ORGA-LINE inner dividing systems
- Well-organised work flows using 5 zone planning
- Improved ergonomics using pull-outs/drawers instead of shelves in the base cabinet
- Optimal access and overview using full extensions and ORGA-LINE inner dividers
- Improved quality of motion when opening and closing



“Provisions” zone

Provisions such as noodles/pasta, flour, rice, semolina and cocoa are stored in the “Consumables” kitchen zone, which also encompasses the refrigerator and freezer.

ORGA-LINE for:

- Kitchen supplies



“Storage” zone

Utensils that are used on a daily basis are placed in the “Non-consumables” kitchen zone. Things that are used on a daily basis include dishes, glasses, cutlery as well as empty plastic containers.

ORGA-LINE for:

- Cutlery
- Odds and ends
- Plates & crockery
- Empty plastic containers



“Cleaning” zone

The sink and dishwasher form the centre of the “Cleaning” kitchen zone. This is the perfect location for both cleaning utensils and waste storage/separation.

ORGA-LINE for:

- Cleaning utensils
- Cleaning materials
- Waste storage/separation



“Preparation” zone

The “Preparation” kitchen zone is the main work area of the kitchen. Meals are prepared here. Kitchen utensils, knives, electric appliances, spices as well as many other items need to be kept close to the work area.

ORGA-LINE for:

- Kitchen utensils, knives, small electric appliances
- Open provisions
- Spices
- Bottles
- Bottles and Cutting boards
- Bottles and provisions



“Cooking” zone

The “Cooking” zone is arranged around the hob and oven. This area is the best place for cooking and baking ingredients, pots, cooking utensils and baking sheets.

ORGA-LINE for:

- Cooking utensils
- Pots, lids, pans and cooking utensils
- Baking ingredients
- Baking trays and baking ware



ORGA-LINE for provisions



- ☑ High fronted pull-out
- ☑ Inner pull-out
- ☑ SPACE CORNER

Lots of space for provisions

The storage space in pull-outs as well as the corner cabinet area can be properly organised using adjustable cross and lateral dividers. Provisions are well organised, won't tip over and are easily accessible. A quick look in the larder unit is all you need to make your shopping/grocery list.

Order specification:

Standard carcass widths:

Cross divider cut to size

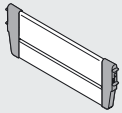

Carcass width	white or grey	Stainless steel
	Steel	(inox)
300 mm	Z40H177S	Z40H177I
400 mm	Z40H277S	Z40H277I
450 mm	Z40H327S	Z40H327I
500 mm	Z40H377S	Z40H377I
550 mm	Z40H427S	Z40H427I
600 mm	Z40H477S	Z40H477I
800 mm	Z40H677S	Z40H677I
900 mm	Z40H777S	Z40H777I
1.000 mm	Z40H877S	Z40H877I
1.200 mm	Z40H1077S	Z40H1077I

Lateral divider



Length 100 mm	white or grey	Stainless steel
	Steel	(inox)
	Z43H100S	Z43H100I

Special carcass widths / SPACE CORNER:

Cross divider for cutting to size

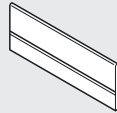

Cutting:
Internal carcass width –87 mm
Length 1077 mm

white, grey or
nickel plated
Z40H1077A

Cross divider connector



RAL 7037 dust grey
nylon
2 pcs. per cross divider
Z40H000A

Lateral divider



Length 100 mm	white or grey	Stainless steel
	Steel	(inox)
	Z43H100S	Z43H100I

Recommended number of cross and lateral dividers

Carcass width [mm]	Nominal length [mm]				
	450	500	550	600	650
300	1 x cross divider		2 x cross divider		
400	1 x cross divider		2 x cross divider		
450	1 x cross divider		2 x cross divider		
500	1 x cross divider		2 x cross divider		
550	2 x lateral dividers		3 x lateral dividers		
600	2 x lateral dividers		3 x lateral dividers		
800	1 x cross divider		2 x cross divider		
900	3 x lateral dividers		6 x lateral dividers		
1.000	3 x lateral dividers		6 x lateral dividers		
1.200	3 x lateral dividers		6 x lateral dividers		
Special carcass widths	Cross divider for cutting to size (quantity see above)				
SPACE CORNER	1 x cross divider cut to size 2 x cross divider connectors 2 x lateral dividers				

Dimension calculation:

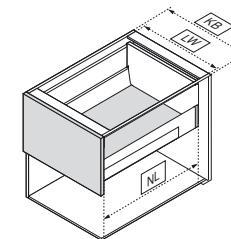

KB Carcass width
NL Nominal length
LW Inner carcass width

ORGA-LINE for cutlery





- Drawer
- Inner drawer
- SPACE CORNER





Organisation for cutlery





High-quality ORGA-LINE sets with dishwasher safe, stainless steel compartments provide proper organisation for your cutlery. The individual cutlery containers can be laid out to suit your requirements and they are removable – practical for buffets or garden parties.

Order specification:

Fits carcass widths 450 mm and higher

Carcass width	Nominal length	Part no.
275 mm 	450 mm	ZSI.450B1N
	500 mm	ZSI.500B1N
	550 mm	ZSI.550B1N
	600 mm	ZSI.600B1N
	650 mm	ZSI.650B1N
300/350 mm 	450 mm	2x ZSI.450B1N
	500 mm	2x ZSI.500B1N
	550 mm	2x ZSI.550B1N
	600 mm	2x ZSI.600B1N
	650 mm	2x ZSI.650B1N
400 mm 	450 mm	ZSI.450B13
	500 mm	ZSI.500B13
	550 mm	ZSI.550B13
	600 mm	ZSI.600B13
	650 mm	ZSI.650B13

Carcass width	Nominal length	Part no.
450 mm 	450 mm	ZSI.45VE14
	500 mm	ZSI.45VE16
	550 mm	ZSI.45VE17
	600 mm	ZSI.45VE18
	650 mm	ZSI.45VE19
500 mm 	450 mm	ZSI.50VE14
	500 mm	ZSI.50VE16
	550 mm	ZSI.50VE17
	600 mm	ZSI.50VE18
	650 mm	ZSI.50VE19
550 mm 	450 mm	ZSI.55VE14
	500 mm	ZSI.55VE16
	550 mm	ZSI.55VE17
	600 mm	ZSI.55VE18
	650 mm	ZSI.55VE19
600 mm 	450 mm	ZSI.60VE14
	500 mm	ZSI.60VE16
	550 mm	ZSI.60VE17
	600 mm	ZSI.60VE18
	650 mm	ZSI.60VE19
800 mm 	450 mm	ZSI.80VE14
	500 mm	ZSI.80VE16
	550 mm	ZSI.80VE17
	600 mm	ZSI.80VE18
	650 mm	ZSI.80VE19

Carcass width	Nominal length	Part no.
900 mm 	450 mm	ZSI.90VE14
	500 mm	ZSI.90VE16
	550 mm	ZSI.90VE17
	600 mm	ZSI.90VE18
	650 mm	ZSI.90VE19
1.000 mm 	450 mm	ZSI.10VE14
	500 mm	ZSI.10VE16
	550 mm	ZSI.10VE17
	600 mm	ZSI.10VE18
	650 mm	ZSI.10VE19
1.200 mm 	450 mm	ZSI.12VE14
	500 mm	ZSI.12VE16
	550 mm	ZSI.12VE17
	600 mm	ZSI.12VE18
	650 mm	ZSI.12VE19
SPACE CORNER		
Installation dimension		
900–1.200 mm		
	600 mm	ZSI.450B13E
	650 mm	ZSI.500B13E

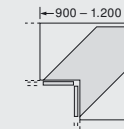

ORGA-LINE for odds and ends



- Drawer
- Inner drawer
- SPACE CORNER

Space for all your odds and ends

A drawer for all kinds of odds and ends is essential for a kitchen. Each item and utensil is stored properly in durable stainless steel boxes. Pencils, papers or paper clips – everything is stored neatly and close to hand when needed.

Order specification:

Fits carcass widths 600 mm and higher

Carcass width	Nominal length	Part no.
275–400 mm	450 mm	ZSI.450BI1N
	500 mm	ZSI.500BI1N
	550 mm	ZSI.550BI1N
	600 mm	ZSI.600BI1N
	650 mm	ZSI.650BI1N
450–550 mm	450 mm	ZSI.450MI3
	500 mm	ZSI.500MI3
	550 mm	ZSI.550MI3
	600 mm	ZSI.600MI3
	650 mm	ZSI.650MI3
600 mm	450 mm	ZSI.60VKI4
	500 mm	ZSI.60VKI6
	550 mm	ZSI.60VKI7
	600 mm	ZSI.60VKI8
	650 mm	ZSI.60VKI9

Carcass width	Nominal length	Part no.
800 mm	450 mm	ZSI.80VKI4
	500 mm	ZSI.80VKI6
	550 mm	ZSI.80VKI7
	600 mm	ZSI.80VKI8
	650 mm	ZSI.80VKI9

900 mm	450 mm	ZSI.90VKI4
	500 mm	ZSI.90VKI6
	550 mm	ZSI.90VKI7
	600 mm	ZSI.90VKI8
	650 mm	ZSI.90VKI9

1.000 mm	450 mm	ZSI.10VKI4
	500 mm	ZSI.10VKI6
	550 mm	ZSI.10VKI7
	600 mm	ZSI.10VKI8
	650 mm	ZSI.10VKI9

SPACE CORNER

Installation dimension

900–1.200 mm	600 mm	ZSI.450MI3E
	650 mm	ZSI.500MI3E

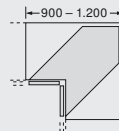

ORGA-LINE for plates/crockery



- ✓ High fronted pull-out
- ✓ Inner pull-out
- ✓ SPACE CORNER

Stacked securely

Storing plates and crockery in a full extension drawer? The ORGA-LINE plate holder makes this ergonomic solution possible – even for corner cabinet areas. Up to 12 plates can be securely stored in each plate holder (no tipping or sliding). They are easy to remove and transport. Setting a large table becomes a snap.

Order specification:

**Standard / Special carcass widths/
SPACE CORNER:**

Plate holder

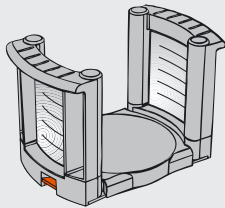

RAL 7037 dust grey
Nylon

ZTH.0350

Plate diameters: 180–320 mm
Overall height: 171 mm
Stacking height of plates: 144 mm

Recommended quantity for the high fronted pull-out
(valid for nominal lengths 450–650 mm):

Starting with carcass width:	400 mm	2 pcs.
	800 mm	4 pcs.
	1.000 mm	6 pcs.

Recommended quantity for SPACE CORNER:

Up to installation dimension:	1.050 mm	2 pcs.
Starting with install. dimension:	1.050 mm	3 pcs.



ORGA-LINE for plastic containers



- High fronted pull-out
- Inner pull-out
- SPACE CORNER

No more searching for lids

With ORGA-LINE, the search for the right container and lid is over. Using a practical full extension drawer, you can see all containers at a glance even into the farthest corner. Cross and lateral dividers provide organisation, with lids simply being stacked neatly on end.

Order specification:

Standard carcass widths:

Cross divider cut to size

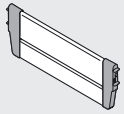

Carcass width	white or grey	Stainless steel
	Steel	(inox)
300 mm	Z40H177S	Z40H177I
400 mm	Z40H277S	Z40H277I
450 mm	Z40H327S	Z40H327I
500 mm	Z40H377S	Z40H377I
550 mm	Z40H427S	Z40H427I
600 mm	Z40H477S	Z40H477I
800 mm	Z40H677S	Z40H677I
900 mm	Z40H777S	Z40H777I
1.000 mm	Z40H877S	Z40H877I
1.200 mm	Z40H1077S	Z40H1077I

Lateral divider



Length 100 mm	white or grey	Stainless steel
	Steel	(inox)
	Z43H100S	Z43H100I

Special carcass widths / SPACE CORNER:

Cross divider for cutting to size

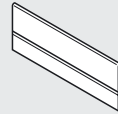

Cutting:
Internal carcass width –87 mm
Length 1077 mm

white, grey or
nickel plated
Z40H1077A

Cross divider connector



RAL 7037 dust grey
Nylon
2 pcs. per cross divider
Z40H000A

Lateral divider



Length 100 mm	white or grey	Stainless steel
	Steel	(inox)
	Z43H100S	Z43H100I

Recommended number of cross and lateral dividers

Carcass width [mm]	Nominal length [mm]				
	450	500	550	600	650
300	1 x cross divider				
400					
450	1 x cross divider 2 x lateral dividers				
500					
550					
600	1 x cross divider 3 x lateral dividers				
800					
900					
1.000	Cross divider for cutting to size (quantity see above)				
1.200					
Special carcass widths	1 x cross divider cut to size 2 x cross divider connectors 2 x lateral dividers				
SPACE CORNER					

Dimension calculation:

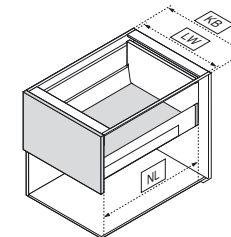

KB Carcass width
NL Nominal length
LW Inner carcass width

ORGA-LINE for cleaning utensils



- High fronted pull-out
- Inner pull-out
- SPACE CORNER

Cleaning utensils readily to hand

Cleaning utensils should ideally be stored in the pull-out directly under the sink. The space to the right and left of the sink bowl is fully exploited. Dish soap, sponge and brush are always readily to hand. No more lengthy searching with wet hands.

Order specification:

Standard / Special carcass widths:

Cross divider for cutting to size

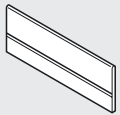

Cutting:
Base width (BB) –16 mm
Length 1077 mm

white, grey or
nickel plated
Z40H1077A

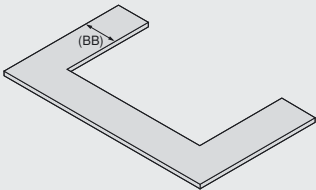

Cross divider connector



RAL 7037 dust grey
Nylon

2 pcs. per cross divider

Z40H000A

We recommend using two cross dividers per side.



ORGA-LINE
for household cleaning utensils





- Drawer
- Inner drawer
- SPACE CORNER



Everything you need for cleaning

An inner drawer in the lower sink cabinet provides additional organisation. Using an ORGA-LINE inner dividing system, you can properly store cleaning utensils such as sponges, kitchen towels or rubbish bags. The individual containers are made from stainless steel making them dishwasher safe and very easy to clean.

Order specification:

Fits carcase widths 600 mm and higher

Carcase width	Nominal length	Part no.
600 mm 	450 mm	ZSI.60VUI4
	500 mm	ZSI.60VUI6
	550 mm	ZSI.60VUI7
	600 mm	ZSI.60VUI8
	650 mm	ZSI.60VUI9
800 mm 	450 mm	ZSI.80VUI4
	500 mm	ZSI.80VUI6
	550 mm	ZSI.80VUI7
	600 mm	ZSI.80VUI8
	650 mm	ZSI.80VUI9
900 mm 	450 mm	ZSI.90VUI4
	500 mm	ZSI.90VUI6
	550 mm	ZSI.90VUI7
	600 mm	ZSI.90VUI8
	650 mm	ZSI.90VUI9

Carcase width	Nominal length	Part no.
1.000 mm 	450 mm	ZSI.10VUI4
	500 mm	ZSI.10VUI6
	550 mm	ZSI.10VUI7
	600 mm	ZSI.10VUI8
	650 mm	ZSI.10VUI9
1.200 mm 	450 mm	ZSI.12VUI4
	500 mm	ZSI.12VUI6
	550 mm	ZSI.12VUI7
	600 mm	ZSI.12VUI8
	650 mm	ZSI.12VUI9



**ORGA-LINE for waste/recycling
and cleaning material storage**

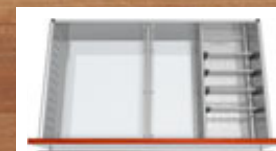

- High fronted pull-out
- Inner pull-out
- SPACE CORNER

No mess no fuss

The sink base unit contains the most frequently used kitchen pull-out because this is where the rubbish/recycling containers are located. For this reason, easy accessibility and secure storage as well as cleanliness are very important. Cleaning materials are stored hygienically in the ORGA-LINE bottle holder and kept separate from the recycling/rubbish holders via a dividing wall. Now rubbish separation can be done with no mess and no fuss.

Order specification:

Standard and special carcass widths starting at 800 mm:

Bottle set

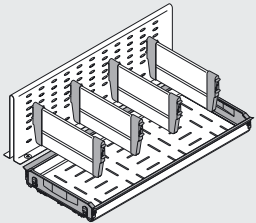

Nominal Length	white or grey	Stainless steel
	Steel	(inox)
450 mm	ZFI.30BZS4N	ZFI.30BZI4N
500 mm	ZFI.30BZS6N	ZFI.30BZI6N
550 mm	ZFI.30BZS7N	ZFI.30BZI7N
600 mm	ZFI.30BZS8N	ZFI.30BZI8N
650 mm	ZFI.30BZS9N	ZFI.30BZI9N

Dividing wall (additional)

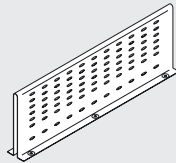

Nominal Length	white or grey	Stainless steel
	Steel	(inox)
450 mm	Z46C420S	Z46C420I
500 mm	Z46C470S	Z46C470I
550 mm	Z46C520S	Z46C520I
600 mm	Z46C570S	Z46C570I
650 mm	Z46C620S	Z46C620I

You will require an additional dividing wall for carcass widths 900 mm and higher.

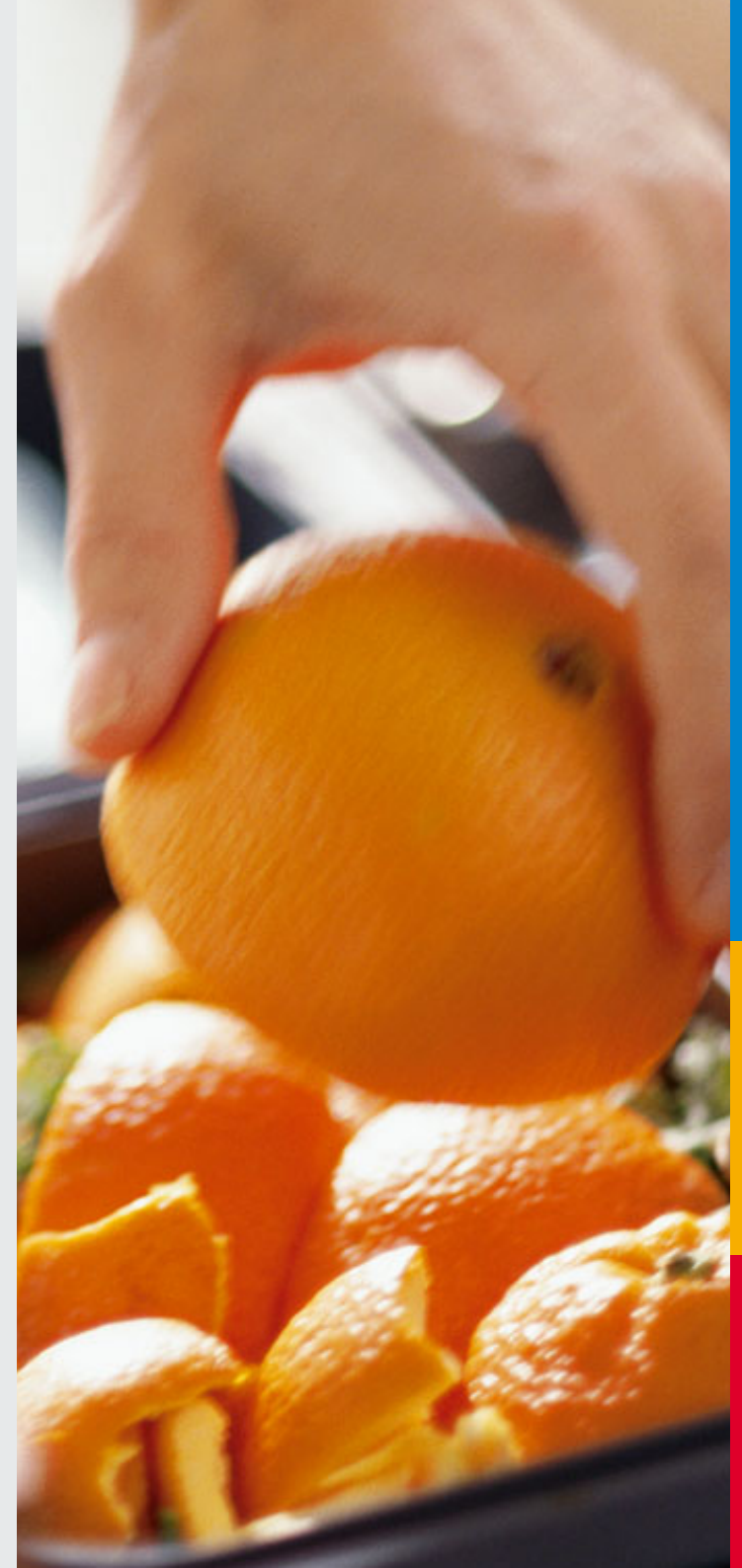

ORGA-LINE for kitchen utensils,
knives and small electric appliances



- Drawer
- Inner drawer
- SPACE CORNER

Direct access

ORGA-LINE inner dividing systems provide organisation and secure storage for drawers with kitchen utensils, knives and small electrical appliances. Everything that you could need for preparing meals is securely stored here. The ORGA-LINE knife block safely stores up to nine knives of different sizes. Even large knives with heavy handles are held firmly in place thanks to the handle support.

Order specification:
Fits carcass widths 600 mm and higher

Carcass width	Nominal length	Part no.
275–300 mm	450 mm	ZSI.450B1N
	500 mm	ZSI.500B1N
	550 mm	ZSI.550B1N
	600 mm	ZSI.600B1N
	650 mm	ZSI.650B1N
400–550 mm	450 mm	ZSI.450F12N
	500 mm	ZSI.500F12N
	550 mm	ZSI.550F12N
	600 mm	ZSI.600F12N
	650 mm	ZSI.650F12N

Carcass width	Nominal length	Part no.
600 mm	450 mm	ZSI.60VUI4
	500 mm	ZSI.60VUI6
	550 mm	ZSI.60VUI7
	600 mm	ZSI.60VUI8
	650 mm	ZSI.60VUI9
800 mm	450 mm	ZSI.80VUI4
	500 mm	ZSI.80VUI6
	550 mm	ZSI.80VUI7
	600 mm	ZSI.80VUI8
	650 mm	ZSI.80VUI9
900 mm	450 mm	ZSI.90VUI4
	500 mm	ZSI.90VUI6
	550 mm	ZSI.90VUI7
	600 mm	ZSI.90VUI8
	650 mm	ZSI.90VUI9
1.000 mm	450 mm	ZSI.10VUI4
	500 mm	ZSI.10VUI6
	550 mm	ZSI.10VUI7
	600 mm	ZSI.10VUI8
	650 mm	ZSI.10VUI9
1.200 mm	450 mm	ZSI.12VUI4
	500 mm	ZSI.12VUI6
	550 mm	ZSI.12VUI7
	600 mm	ZSI.12VUI8
	650 mm	ZSI.12VUI9

SPACE CORNER Installation dimension

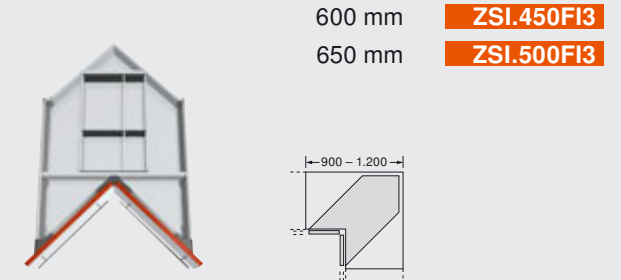

Knife block

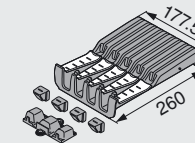

RAL 7037 dust grey
Nylon
ZSZ.02M0

Suitable for carcass widths 400 mm and higher.
Can also be used in the utensil divider.

ORGA-LINE for open provisions

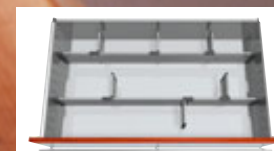

- ✓ High fronted pull-out
- ✓ Inner pull-out
- ✓ SPACE CORNER

Organisation saves time

Opened packets of provisions such as flour, sugar and rice can be stored under the main work area. High cross and lateral dividers ensure that goods are held securely yet are easy to view and access. So when you need it, the right ingredient is close at hand.

Order specification:

Standard carcass widths:

Cross divider cut to size

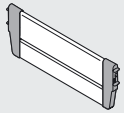

Carcass width	white or grey	Stainless steel
	Steel	(inox)
300 mm	Z40H177S	Z40H177I
400 mm	Z40H277S	Z40H277I
450 mm	Z40H327S	Z40H327I
500 mm	Z40H377S	Z40H377I
550 mm	Z40H427S	Z40H427I
600 mm	Z40H477S	Z40H477I
800 mm	Z40H677S	Z40H677I
900 mm	Z40H777S	Z40H777I
1.000 mm	Z40H877S	Z40H877I
1.200 mm	Z40H1077S	Z40H1077I

Lateral divider



Length 100 mm	white or grey	Stainless steel
	Steel	(inox)
	Z43H100S	Z43H100I

Special carcass widths / SPACE CORNER:

Cross divider for cutting to size

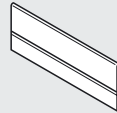

Cutting:
Internal carcass width –87 mm
Length 1077 mm

white, grey or
nickel plated
Z40H1077A

Cross divider connector



RAL 7037 dust grey
Nylon
2 pcs. per cross divider
Z40H000A

Lateral divider



Length 100 mm	white or grey	Stainless steel
	Steel	(inox)
	Z43H100S	Z43H100I

Recommended number of cross and lateral dividers

Carcass width [mm]	Nominal length [mm]				
	450	500	550	600	650
300	1 x cross divider		2 x cross divider		
400	1 x cross divider		2 x cross divider		
450	1 x cross divider		2 x cross divider		
500	1 x cross divider		2 x cross divider		
550	2 x lateral dividers		3 x lateral dividers		
600	2 x lateral dividers		3 x lateral dividers		
800	1 x cross divider		2 x cross divider		
900	3 x lateral dividers		6 x lateral dividers		
1.000	3 x lateral dividers		6 x lateral dividers		
1.200	3 x lateral dividers		6 x lateral dividers		
Special carcass widths	Cross divider for cutting to size (quantity see above)				
SPACE CORNER	1 x cross divider cut to size 2 x cross divider connectors 2 x lateral dividers				

Dimension calculation:

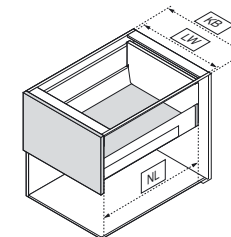

KB Carcass width
NL Nominal length
LW Inner carcass width

ORGA-LINE for spices



- High fronted pull-out
- Inner pull-out
- SPACE CORNER

Organisation for spices

When preparing meals and cooking, the right spices/herbs should always be close at hand. The ORGA-LINE spice holder securely stores both small and large containers – all within easy reach. An optional base stabilizer provides additional support in wider pull-outs.

The spice holder can be completely removed from the pull-out and set out on the work surface or carried to the table. It is also very easy to clean – it's even dishwasher safe.

Order specification:

Standard carcass widths:

The spice holder

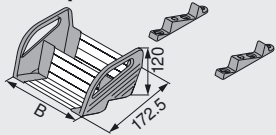

Stainless steel
(inox)

Carcass width	Width (B)		
300 mm	212 mm	2x	ZFZ.30G0I
400 mm	312 mm	2x	ZFZ.40G0I
450 mm	362 mm	2x	ZFZ.45G0I

Cross divider cut to size

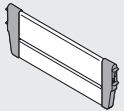

white or grey Steel Stainless steel
(inox)

Carcass width	Steel	Stainless steel (inox)
300 mm	Z40H177S	Z40H177I
400 mm	Z40H277S	Z40H277I
450 mm	Z40H327S	Z40H327I

Lateral divider



white or grey Steel Stainless steel
(inox)

Length 100 mm	Z43H100S	Z43H100I
---------------	-----------------	-----------------

Special carcass widths:

The spice holder

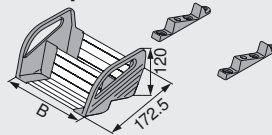

Stainless steel

Carcass width	Width (B)		
450 mm a. higher	212 mm	2x	ZFZ.30G0I
	312 mm	2x	ZFZ.40G0I
	362 mm	2x	ZFZ.45G0I

Cross divider for cutting to size

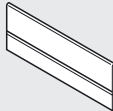

Cutting: white, grey or nickel plated
Internal carcass width –87 mm
Length 1077 mm **Z40H1077A**

Cross divider connector



RAL 7037 dust grey
Nylon

2 pcs. per cross divider **Z40H000A**

Lateral divider (see standard carcass widths)

Recommended number of cross and lateral dividers

Carcass width [mm]	Nominal length [mm]				
	450	500	550	600	650
300	1 x cross divider		2 x cross divider		
400	1 x cross divider		2 x cross divider		
450	1 x cross divider 2 x lateral dividers		2 x cross divider 3 x lateral dividers		
Special carcass widths	Cross divider for cutting to size (quantity see above)				

Dimension calculation:

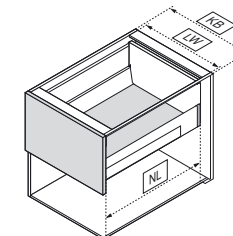

KB Carcass width
NL Nominal length
LW Inner carcass width



ORGA-LINE for bottles



- High fronted pull-out
- Inner pull-out
- SPACE CORNER

For high expectations

The high fronted pull-out is especially well-suited for storing bottles of every size. Adjustable cross dividers ensure bottles are held securely in place. Easy access to oils, vinegar, marinades and dressings. The stainless steel drip tray is very easy to clean.

Order specification:

For standard carcass widths:

Drip tray

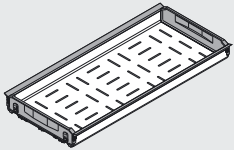

Nominal Length	Carcass width	
	275 mm	300 mm
450 mm	–	Z48.30B014
500 mm	Z48.27B016	Z48.30B016
550 mm	Z48.27B017	Z48.30B017
600 mm	Z48.27B018	Z48.30B018
650 mm	Z48.27B019	Z48.30B019

Cross divider cut to size

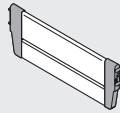

Carcass width	white or grey	Stainless steel
	Steel	(inox)
275 mm	Z40H152S	Z40H152I
300 mm	Z40H177S	Z40H177I

Recommended number of cross dividers

Carcass width [mm]	Nominal length [mm]				
	450	500	550	600	650
275	3 x cross dividers	4 x cross dividers	5 x cross dividers	5 x cross dividers	5 x cross dividers
300					

Dimension calculation:

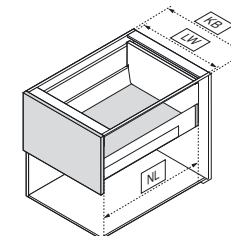

KB Carcass width
NL Nominal length
LW Inner carcass width

ORGA-LINE
for bottles and cutting boards



- High fronted pull-out
- Inner pull-out
- SPACE CORNER

Hygienic solution

The high pull-out can now also be adapted to store cutting boards along with bottles. This highly practical solution makes it easy to find the right cutting board and saves unnecessary bending and stretching.

If the contents of one of the bottles should leak then; no problem. The removable stainless steel tray of the ORGA-LINE set is very easy to clean.

Order specification:

Standard carcass widths starting with 400 mm:

Bottle set

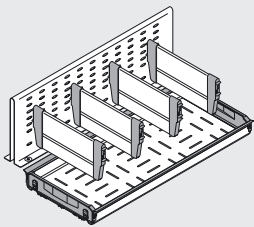

Nominal Length	white or grey	Stainless steel
	Steel	(inox)
450 mm	ZFI.30BZS4N	ZFI.30BZI4N
500 mm	ZFI.30BZS6N	ZFI.30BZI6N
550 mm	ZFI.30BZS7N	ZFI.30BZI7N
600 mm	ZFI.30BZS8N	ZFI.30BZI8N
650 mm	ZFI.30BZS9N	ZFI.30BZI9N

You will require an additional dividing wall for carcass widths 500 mm and higher.

Dividing wall (additional)

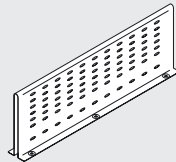

Nominal Length	white or grey	Stainless steel
	Steel	(inox)
450 mm	Z46C420S	Z46C420I
500 mm	Z46C470S	Z46C470I
550 mm	Z46C520S	Z46C520I
600 mm	Z46C570S	Z46C570I
650 mm	Z46C620S	Z46C620I

Start. with carcass width: 500 mm 1 pcs.
600 mm 2 pcs.



ORGA-LINE
for bottles and provisions



blum



- High fronted pull-out
- Inner pull-out
- SPACE CORNER

Security for bottles and provisions

Thanks to ORGA-LINE, provisions can now be organised alongside bottles in a pull-out. High side walls and adjustable cross and lateral dividers prevent bottles and provisions from falling over. The stainless steel drip tray makes cleaning child's play.

Order specification:

Special carcass widths starting with 900 mm:

Bottle set

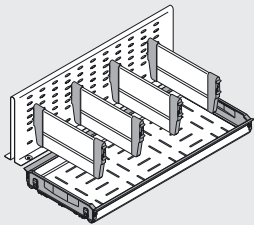

Nominal Length	white or grey	Stainless steel
	Steel	(inox)
450 mm	ZFI.30BZS4N	ZFI.30BZI4N
500 mm	ZFI.30BZS6N	ZFI.30BZI6N
550 mm	ZFI.30BZS7N	ZFI.30BZI7N
600 mm	ZFI.30BZS8N	ZFI.30BZI8N
650 mm	ZFI.30BZS9N	ZFI.30BZI9N

Cross divider for cutting to size

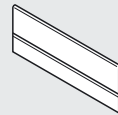

Cutting: white, grey or
External cabinet width –352mm nickel plated
Length 1077 mm **Z40H1077A**

Cross divider connector



RAL 7037 dust grey
Nylon
2 pcs. per cross divider **Z40H000A**

Lateral divider



white or grey
Steel
Length 100 mm **Z43H100S** **Z43H100I**
Stainless steel
(inox)

Recommended number of cross and lateral dividers

Carcass width [mm]	Nominal length [mm]				
	450	500	550	600	650
Special carcass widths	Cross divider for cutting to size				

Dimension calculation:

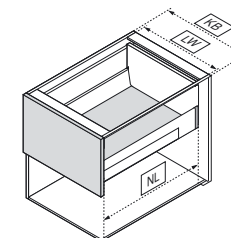

KB Carcass width
NL Nominal length
LW Inner carcass width

ORGA-LINE for cooking utensils



- Drawer
- Inner drawer
- SPACE CORNER

So nothing burns

Whether you are stirring soup or turning meat – the tools you need should be close to hand in the cooking area.

Using ORGA-LINE inner dividing systems, drawers under the hob are well organised providing quick access to the right utensil.

Order specification:

Fits carcass widths 600 mm and higher

Carcass width	Nominal length	Part no.
600 mm	450 mm	ZSI.60VUI4
	500 mm	ZSI.60VUI6
	550 mm	ZSI.60VUI7
	600 mm	ZSI.60VUI8
	650 mm	ZSI.60VUI9
800 mm	450 mm	ZSI.80VUI4
	500 mm	ZSI.80VUI6
	550 mm	ZSI.80VUI7
	600 mm	ZSI.80VUI8
	650 mm	ZSI.80VUI9
900 mm	450 mm	ZSI.90VUI4
	500 mm	ZSI.90VUI6
	550 mm	ZSI.90VUI7
	600 mm	ZSI.90VUI8
	650 mm	ZSI.90VUI9

Carcass width	Nominal length	Part no.
1.000 mm	450 mm	ZSI.10VUI4
	500 mm	ZSI.10VUI6
	550 mm	ZSI.10VUI7
	600 mm	ZSI.10VUI8
	650 mm	ZSI.10VUI9
1.200 mm	450 mm	ZSI.12VUI4
	500 mm	ZSI.12VUI6
	550 mm	ZSI.12VUI7
	600 mm	ZSI.12VUI8
	650 mm	ZSI.12VUI9



ORGA-LINE for pots,
lids, pans and cooking utensils



- High fronted pull-out
- Inner pull-out
- SPACE CORNER

A lid for every pot

Cooking items that are used on a regular basis should be kept near the oven and hob. With ORGA-LINE, you can organise the interior of your high fronted pull-out so that pots and lids are stored together. High back and side walls provide secure storage – preventing pot handles from jutting out. Depending on the need, there is even further space for commonly-used cooking utensils.

Order specification:

Standard carcass widths:

Cross divider cut to size

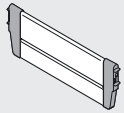

Carcass width	white or grey Steel	Stainless steel (inox)
600 mm	Z40H477S	Z40H477I
800 mm	Z40H677S	Z40H677I
900 mm	Z40H777S	Z40H777I
1.000 mm	Z40H877S	Z40H877I
1.200 mm	Z40H1077S	Z40H1077I

Lateral divider



Length 100 mm	white or grey Steel	Stainless steel (inox)
	Z43H100S	Z43H100I

Special carcass widths / SPACE CORNER:

Cross divider for cutting to size

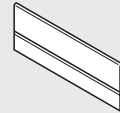

Cutting:
Internal carcass width –87 mm
Length 1077 mm

white, grey or
nickel plated
Z40H1077A

Cross divider connector



RAL 7037 dust grey
Nylon
2 pcs. per cross divider
Z40H000A

Lateral divider



white or grey
Steel
Length 100 mm
Z43H100S

Stainless steel
(inox)
Z43H100I

Recommended number of cross and lateral dividers

Carcass width [mm]	Nominal length [mm]				
	450	500	550	600	650
600	1 x cross divider 2 x lateral dividers		2 x cross divider 3 x lateral dividers		
800	1 x cross divider 3 x lateral dividers		2 x cross divider 6 x lateral dividers		
900					
1.000					
1.200	Cross divider for cutting to size (quantity see above)				
Special carcass widths	Cross divider for cutting to size (quantity see above)				

Dimension calculation:

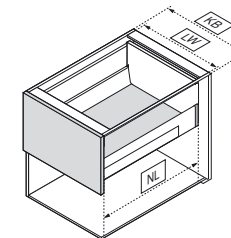

KB Carcass width
NL Nominal length
LW Inner carcass width





- High fronted pull-out
- Inner pull-out
- SPACE CORNER

Everything for baking

Baking ingredients should be kept close to the oven and hob to save time and effort. All ingredients can be stored within easy reach in a spacious high fronted pull-out equipped with ORGA-LINE cross and lateral dividers.

Order specification:

Standard carcase widths:

Cross divider cut to size

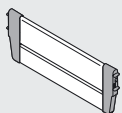

Carcase width	white or grey	Stainless steel
	Steel	(inox)
300 mm	Z40H177S	Z40H177I
400 mm	Z40H277S	Z40H277I
450 mm	Z40H327S	Z40H327I
500 mm	Z40H377S	Z40H377I
550 mm	Z40H427S	Z40H427I
600 mm	Z40H477S	Z40H477I
800 mm	Z40H677S	Z40H677I
900 mm	Z40H777S	Z40H777I
1.000 mm	Z40H877S	Z40H877I
1.200 mm	Z40H1077S	Z40H1077I

Lateral divider



Length 100 mm	white or grey	Stainless steel
	Steel	(inox)
	Z43H100S	Z43H100I

Special carcase widths / SPACE CORNER:

Cross divider for cutting to size

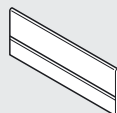

Cutting:
Internal carcase width –87 mm
Length 1077 mm

white, grey or
nickel plated
Z40H1077A

Cross divider connector



2 pcs. per cross divider

RAL 7037 dust grey
nylon
Z40H000A

Lateral divider



Length 100 mm	white or grey	Stainless steel
	Steel	(inox)
	Z43H100S	Z43H100I

Recommended number of cross and lateral dividers

Carcase width [mm]	Nominal length [mm]				
	450	500	550	600	650
300	1 x cross divider	2 x cross divider			
400					
450	1 x cross divider 2 x lateral dividers	2 x cross divider 3 x lateral dividers			
500					
550					
600	1 x cross divider 3 x lateral dividers	2 x cross divider 6 x lateral dividers			
800					
900					
1.000	1 x cross divider 3 x lateral dividers	2 x cross divider 6 x lateral dividers			
1.200					
Special carcase widths	Cross divider for cutting to size (quantity see above)				

Dimension calculation:

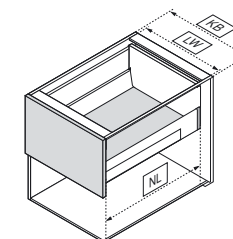

KB Carcase width
NL Nominal length
LW Inner carcase width



ORGA-LINE
for baking trays and accessories



blum

blum



- High fronted pull-out
- Inner pull-out
- SPACE CORNER

ORGA-LINE sets for special carcass widths

It is possible to customise drawers with special widths using ORGA-LINE modular sets.

The customer has the option to integrate further accessories to drawers and pull-outs. (such as; the plate holder, knife block and spice holder).

Sets and accessories for drawers:

SPACE CORNER

Nom. length	Part no.
600 mm	ZSI.450BI3E
650 mm	ZSI.500BI3E

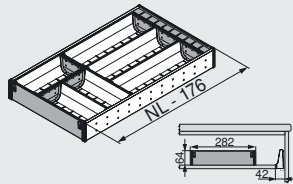

600 mm	ZSI.450MI3E
650 mm	ZSI.500MI3E

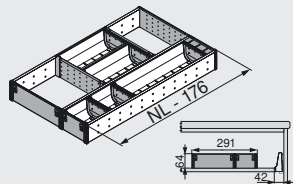

Cutlery sets (B)	Nom. length	Part no.
	450 mm	ZSI.450BI1N
	500 mm	ZSI.500BI1N
	550 mm	ZSI.550BI1N
	600 mm	ZSI.600BI1N
	650 mm	ZSI.650BI1N

	450 mm	ZSI.450BI2N
	500 mm	ZSI.500BI2N
	550 mm	ZSI.550BI2N
	600 mm	ZSI.600BI2N
	650 mm	ZSI.650BI2N

	450 mm	ZSI.450BI3N
	500 mm	ZSI.500BI3
	550 mm	ZSI.550BI3
	600 mm	ZSI.600BI3
	650 mm	ZSI.650BI3

Utensil combination sets (B)	Nom. length	Part no.
	450 mm	ZSI.450FI2N
	500 mm	ZSI.500FI2N
	550 mm	ZSI.550FI2N
	600 mm	ZSI.600FI2N
	650 mm	ZSI.650FI2N

	450 mm	ZSI.450FI3
	500 mm	ZSI.500FI3
	550 mm	ZSI.550FI3
	600 mm	ZSI.600FI3
	650 mm	ZSI.650FI3

Combination sets (K/M)	Nom. length	Part no.
	450 mm	ZSI.450KI2N
	500 mm	ZSI.500KI2N
	550 mm	ZSI.550KI2N
	600 mm	ZSI.600KI2N
	650 mm	ZSI.650KI2N

	450 mm	ZSI.450KI3N
	500 mm	ZSI.500KI3N
	550 mm	ZSI.550KI3N
	600 mm	ZSI.600KI3N
	650 mm	ZSI.650KI3N

	450 mm	ZSI.450KI4N
	500 mm	ZSI.500KI4
	550 mm	ZSI.550KI4
	600 mm	ZSI.600KI4
	650 mm	ZSI.650KI4

	450 mm	ZSI.450MI3
	500 mm	ZSI.500MI3
	550 mm	ZSI.550MI3
	600 mm	ZSI.600MI3
	650 mm	ZSI.650MI3

Accessories

Part no.

Knife block

ZSZ.02M0

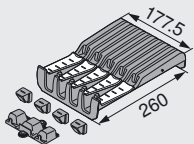

Containers



88 x 88 mm

ZSI.010SI

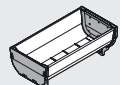

88 x 176 mm

ZSI.020SI

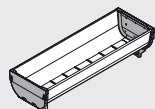

88 x 264 mm

ZSI.030SI

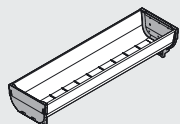

88 x 352 mm

ZSI.040SI

Adjustable cross dividers

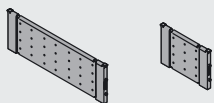

88 mm

ZSI.010Q

176 mm

ZSI.020Q

Accessories for pull-outs:

The spice holder

Part no.

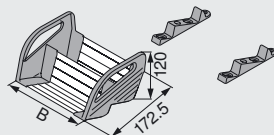

Carcass width Width (B)

300 mm 212 mm

ZFZ.30G0I

400 mm 312 mm

ZFZ.40G0I

450 mm 362 mm

ZFZ.45G0I

Plate holder

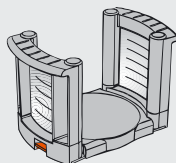

ZTH.0350

Plate diameters:

180–320 mm

Overall height:

171 mm

Stacking height of plates:

144 mm





Reliable, safe, competent

Blum is the reliable and competent partner for you: With the right products, useful services and experienced people.

The wants and needs of our customers represent the driving force for our business.

By engaging in dialogue together we discover new opportunities to perfect motion.

In this way, we can optimise and upgrade our products and services for our customers around the globe – thus benefiting everyone: Furniture manufacturers, furniture sellers, furniture installers and furniture buyers.

Our long established philosophy is to provide real advantages to each of our customers (throughout the supply chain).

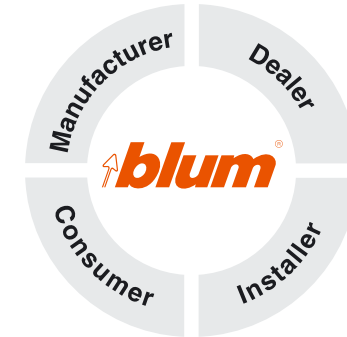

Blum innovations have become milestones in furniture hardware manufacturing. Helping you to provide high quality furniture and inspiration for your customers, through a partnership of design and function.



Our goal is to make opening and closing furniture a truly emotional experience. “Perfecting motion” is our motto. It incorporates everything that is the best about the Blum brand.

www.dynamicspace.com



by Blum

Blum U.K. Ltd.
Mandeville Drive
Kingston, Milton Keynes
GB-Buckinghamshire
MK10 0AW
Tel.: 019 08 28 57 00
Fax: 019 08 28 57 01
E-mail: info.uk@blum.com

Julius Blum GmbH
Furniture Fittings Mfg.
6973 Hoechst, Austria
Tel.: +43 5578 705-0
Fax: +43 5578 705-44
E-mail: info@blum.com
www.blum.com

