

SWS

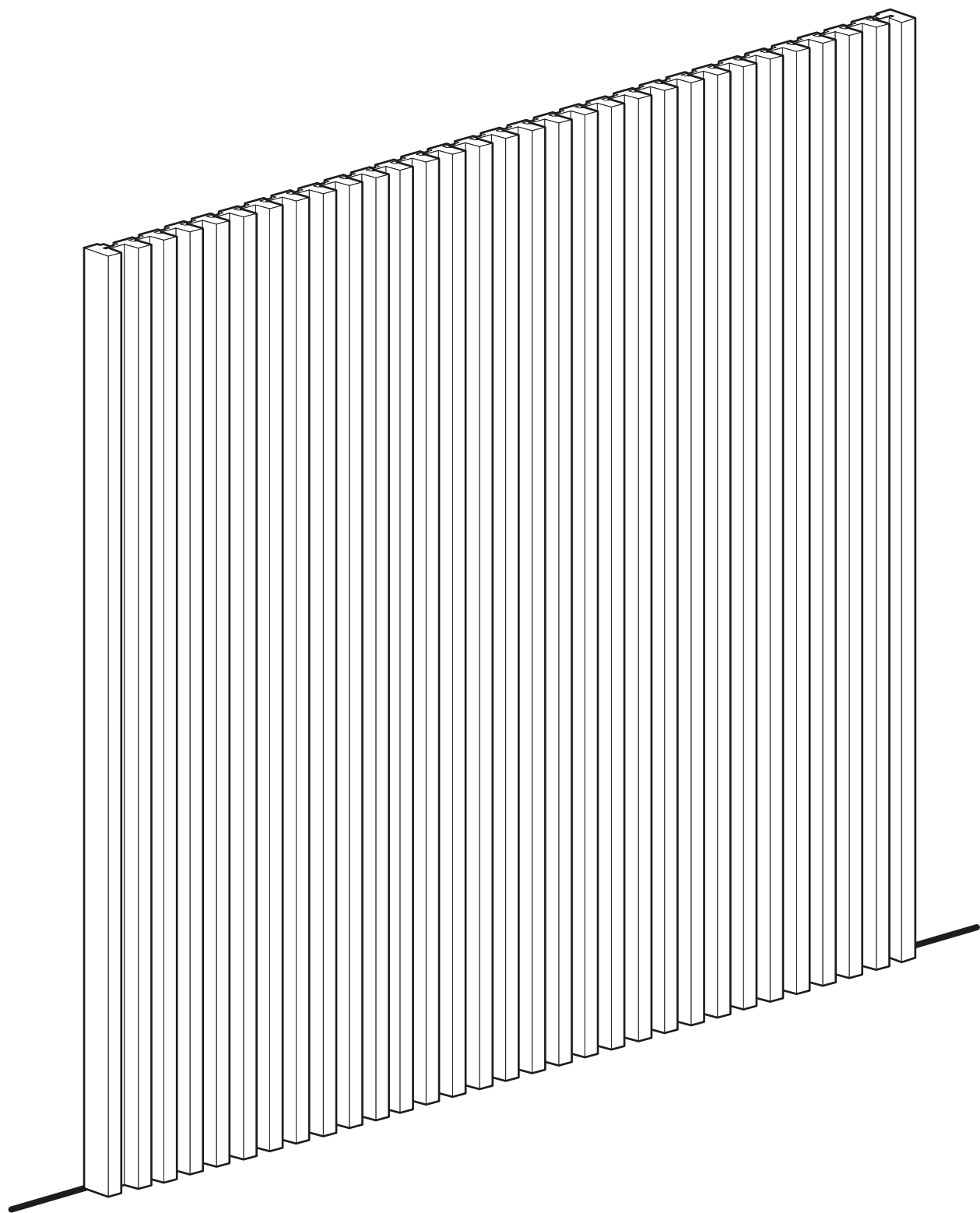

ISTRUZIONI DI MONTAGGIO
ASSEMBLY INSTRUCTIONS
WALL SYSTEM

STRUMENTI / TOOLS

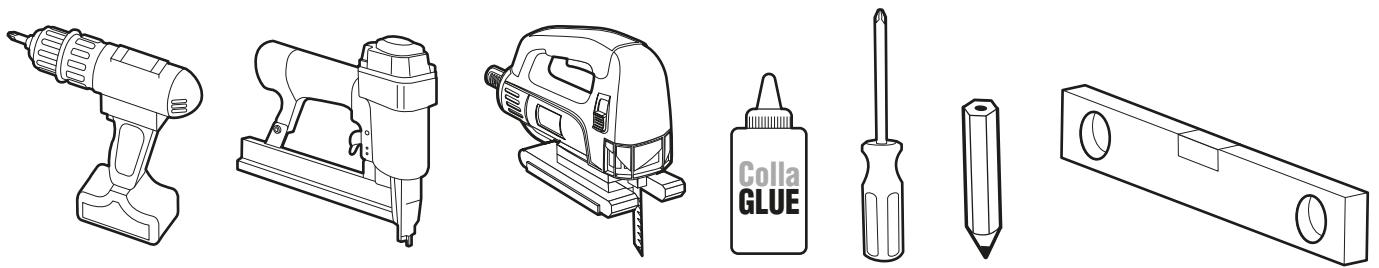

KIT PARETE / KIT ELEMENTS

X

SP. / THK. 1 cm

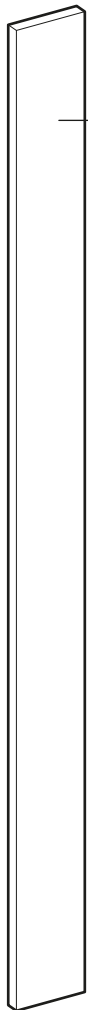

Aste di fissaggio
(pino o abete)
NON INCLUDE

Back fixing profile
(Wood or MDF)
NOT INCLUDED

A

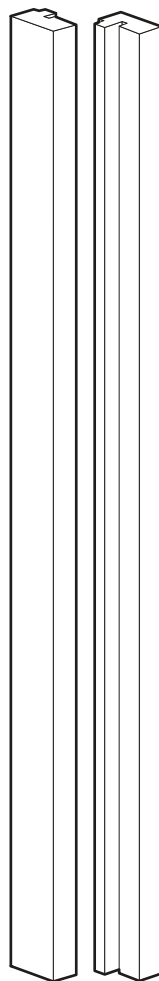

B

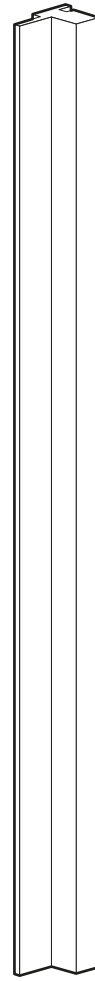
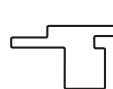

C



D



ESEMPI DI APPLICAZIONE / APPLICATION EXAMPLES

PARETE DRITTA / STRAIGHT COMPOSITION

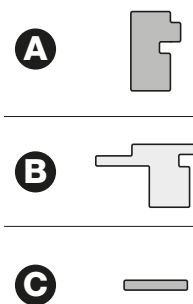
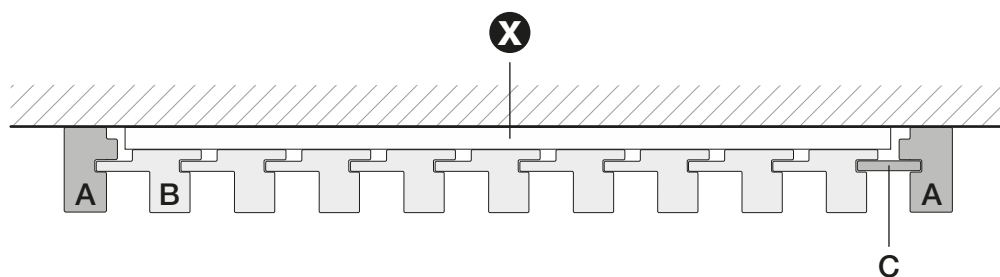

PARETE ANGOLO INTERNO / INTERNAL CORNER COMPOSITION

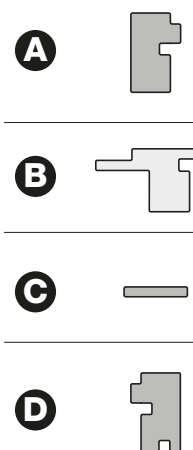
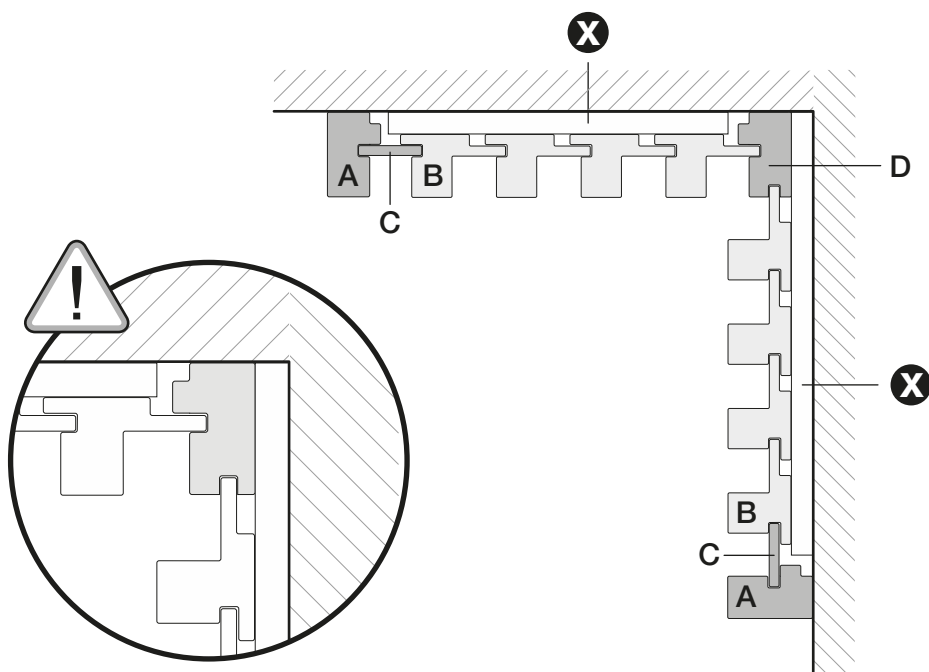

PARETE ANGOLO ESTERNO / EXTERNAL CORNER COMPOSITION

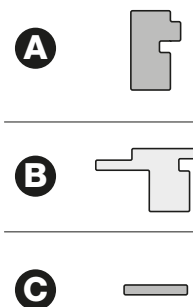
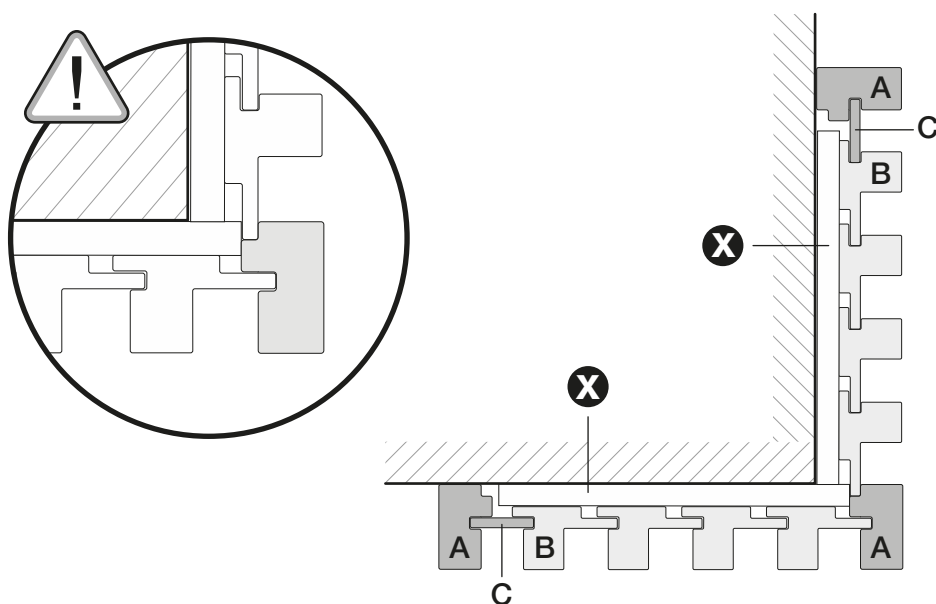

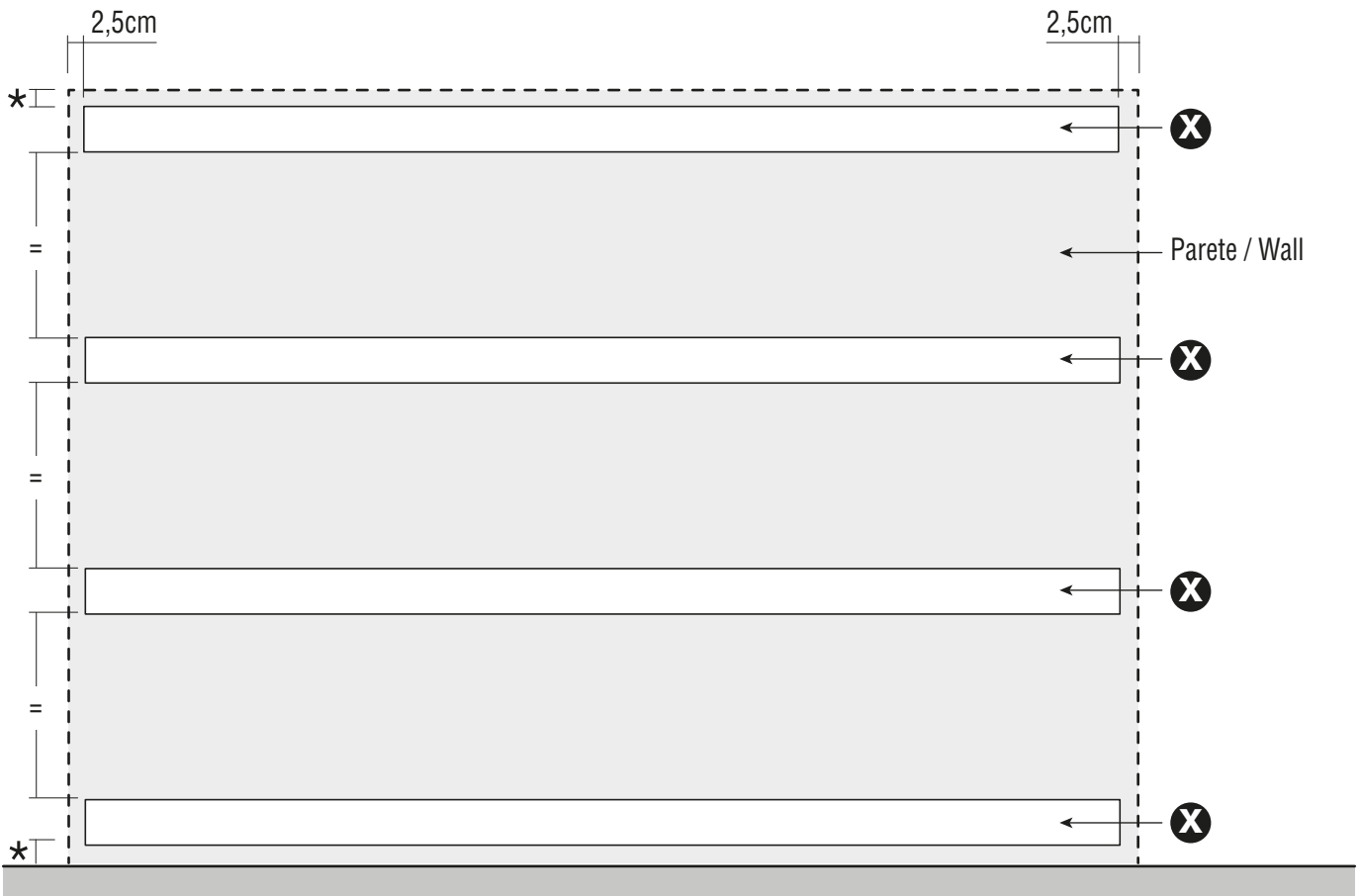

= Le aste dovranno essere di **spessore 1cm.**
 = The back profile must be **1 cm thickness**



= **Consigliamo** di mantenere la distanza di 1cm dal soffitto e dal pavimento
 = **It's recommended** to keep 1 cm distance, from the ceiling and the floor

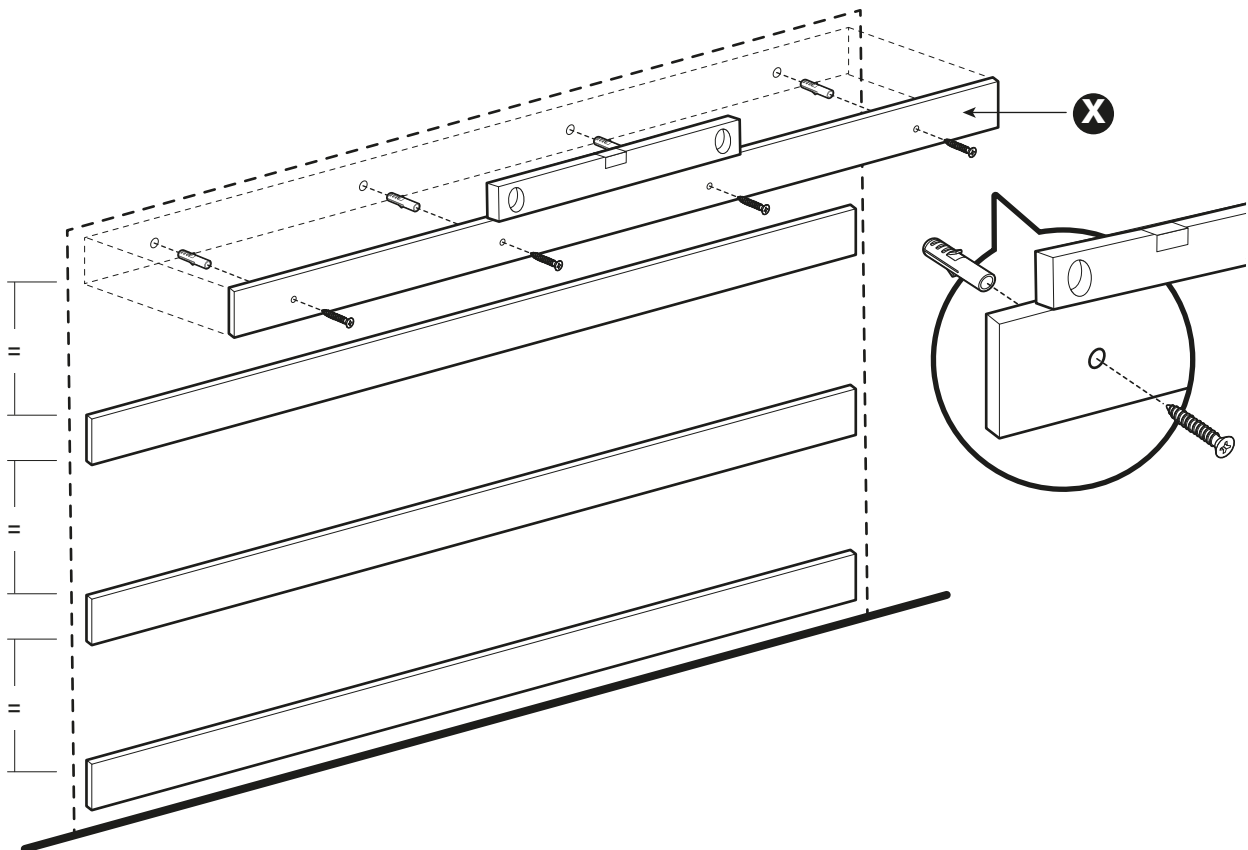

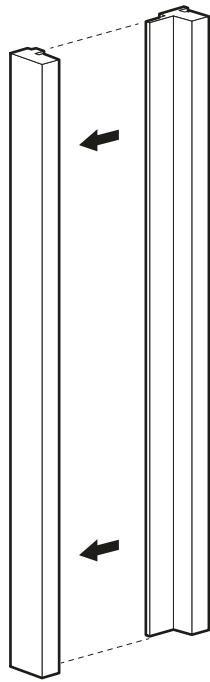
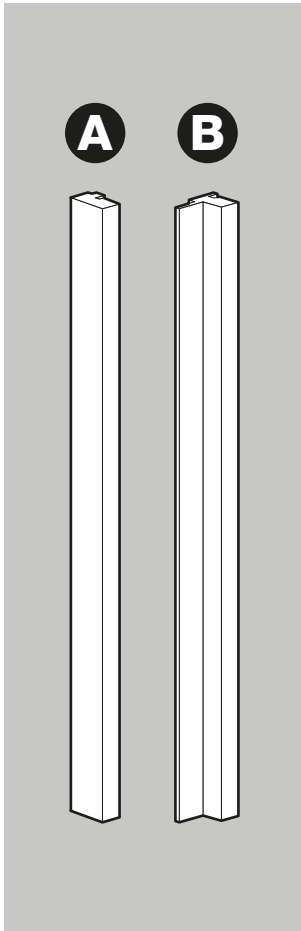

Applicare la colla
Apply glue in the groove

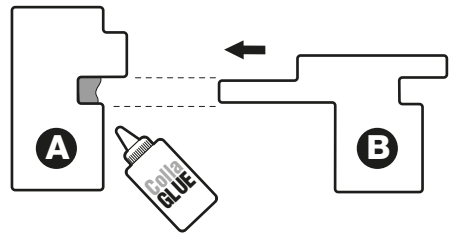

Attendere che la colla faccia presa
Wait for the glue to dry

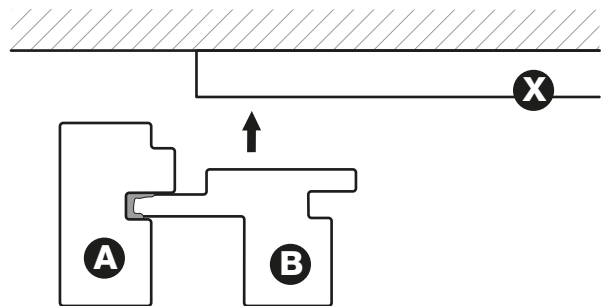
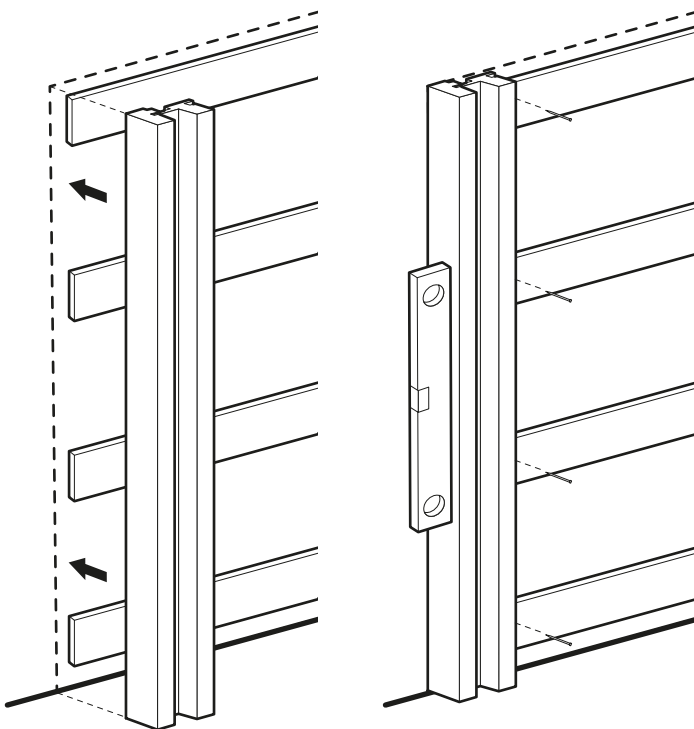
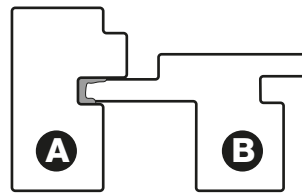

Fissare l'asta B con i chiodini nella posizione indicata
Fix B profile with nails in the indicated position

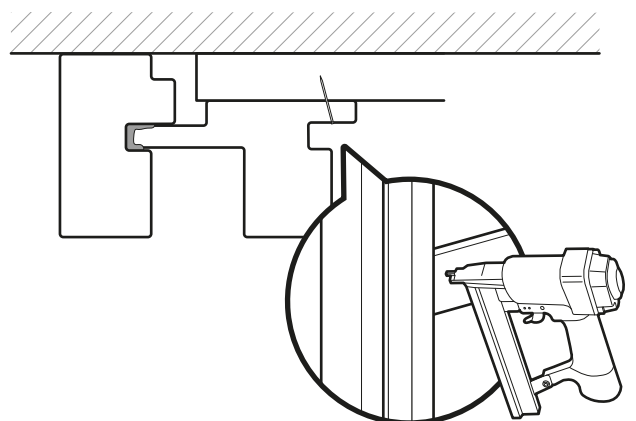

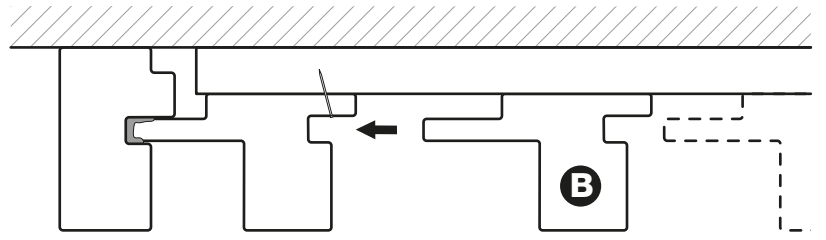
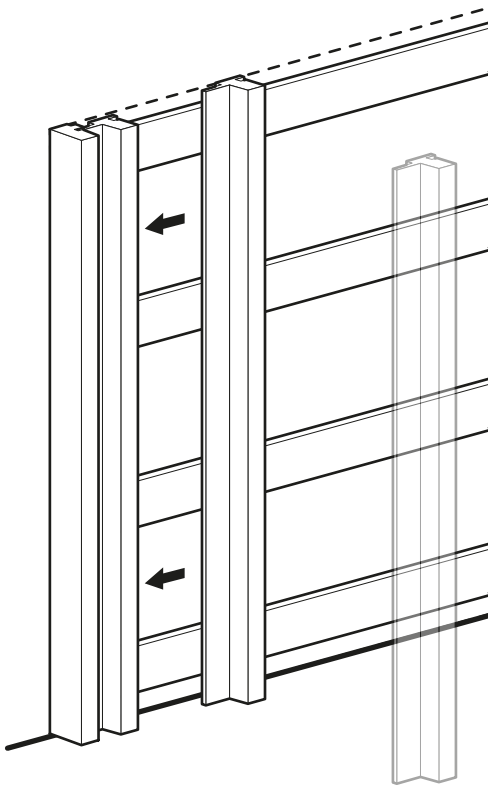

Completare tutta la parete desiderata fissando le singole aste **B** con i chiodini
 Complete the wall by fixing **B** profile with nails

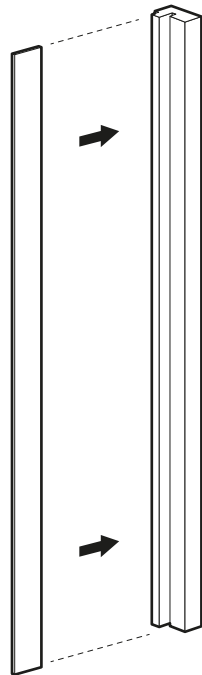
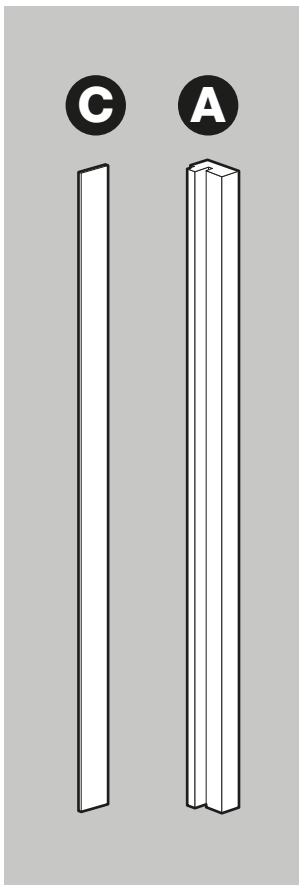
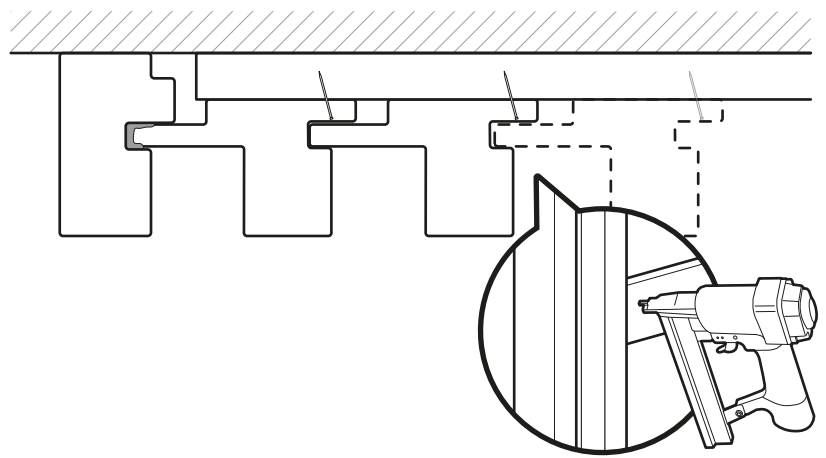

Applicare la colla
 Apply glue in the groove

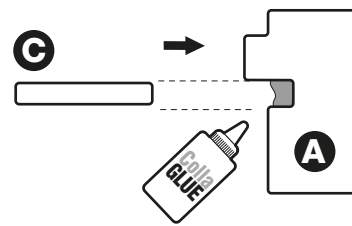

Attendere che la colla faccia presa
 Wait for the glue to dry

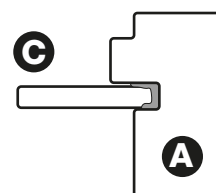

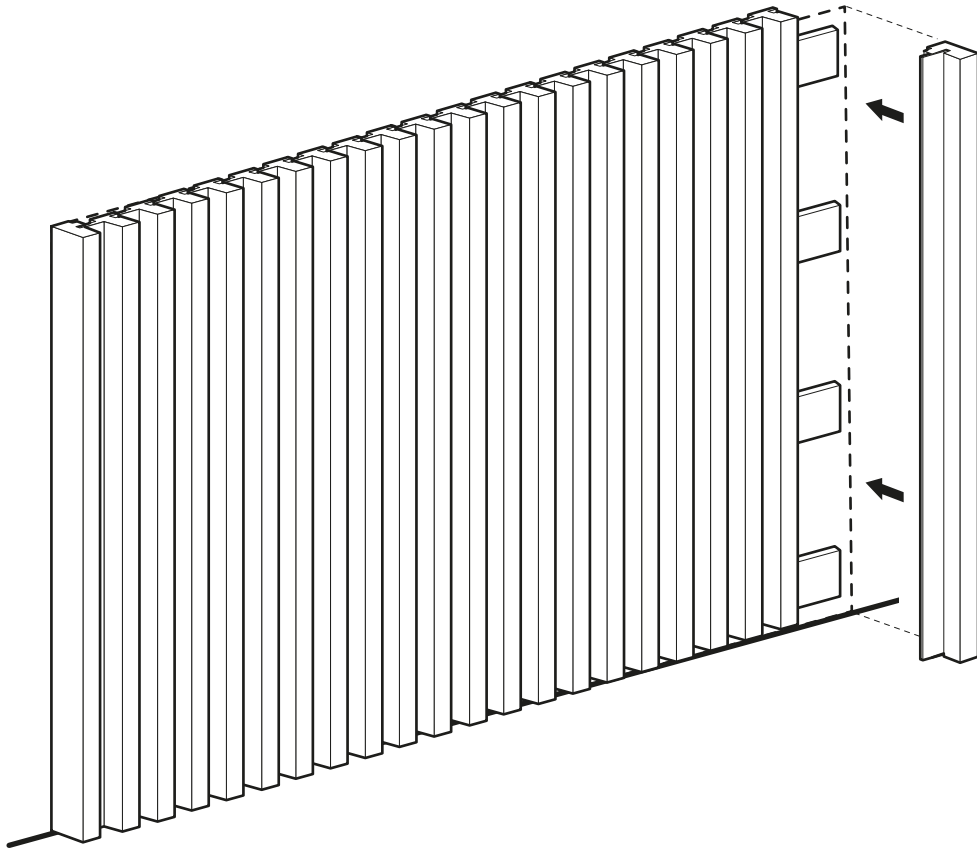

Applicare la colla
Apply glue in the groove

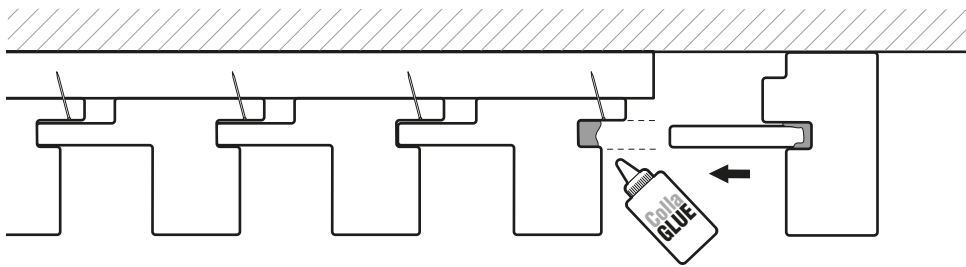

Applicare la colla
Attendere che la colla faccia presa
Wait for the glue to dry

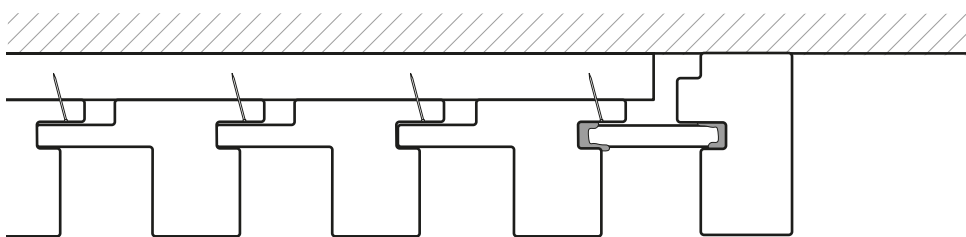

SWS